



UML 2.4.1 Referenz

Orientation in Objects GmbH

Weinheimer Str. 68
68309 Mannheim

www.oio.de
info@oio.de

Version: 12.1

Allgemeine Notationselemente

Common Notation Elements

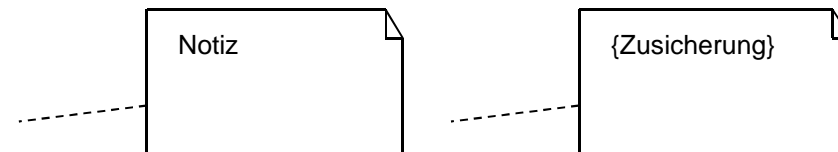

Abhängigkeit →

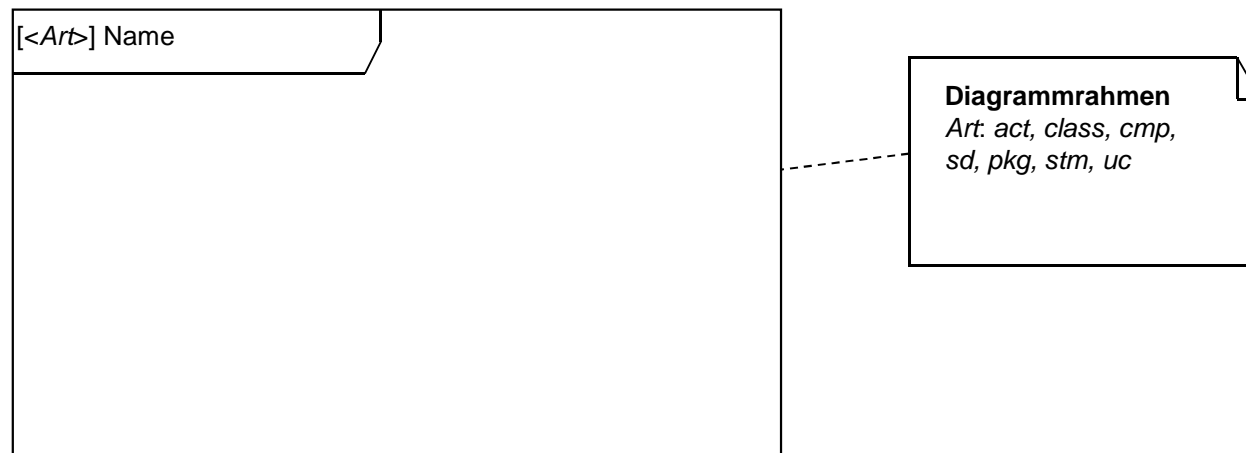

Paketdiagramm

Package Diagram

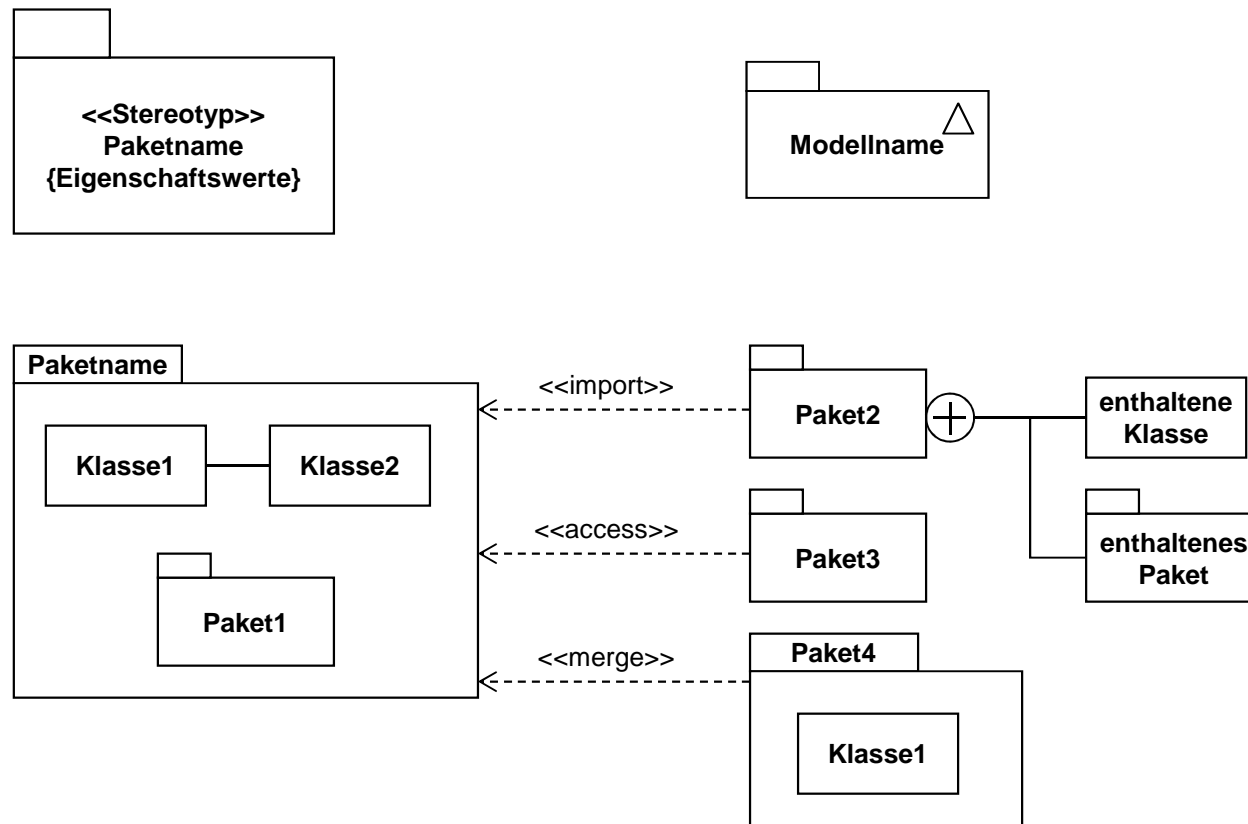

Profildiagramm

Profile Diagram

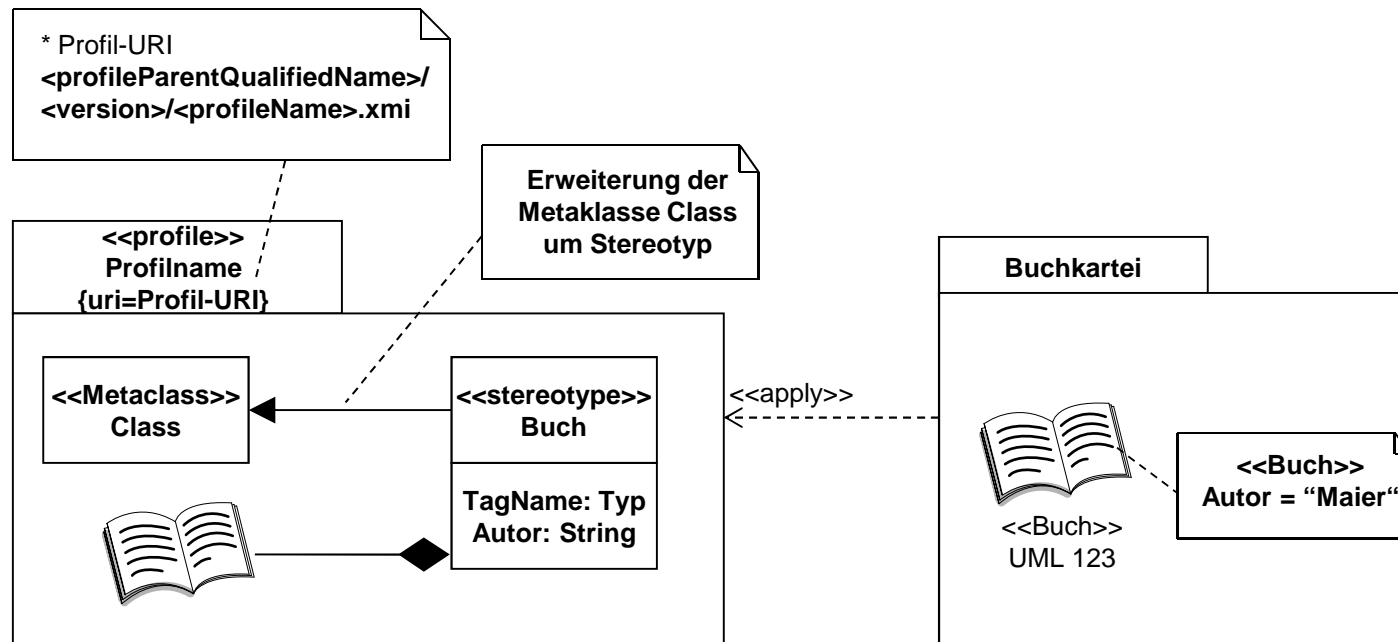

Klassendiagramm 1

Class Diagram

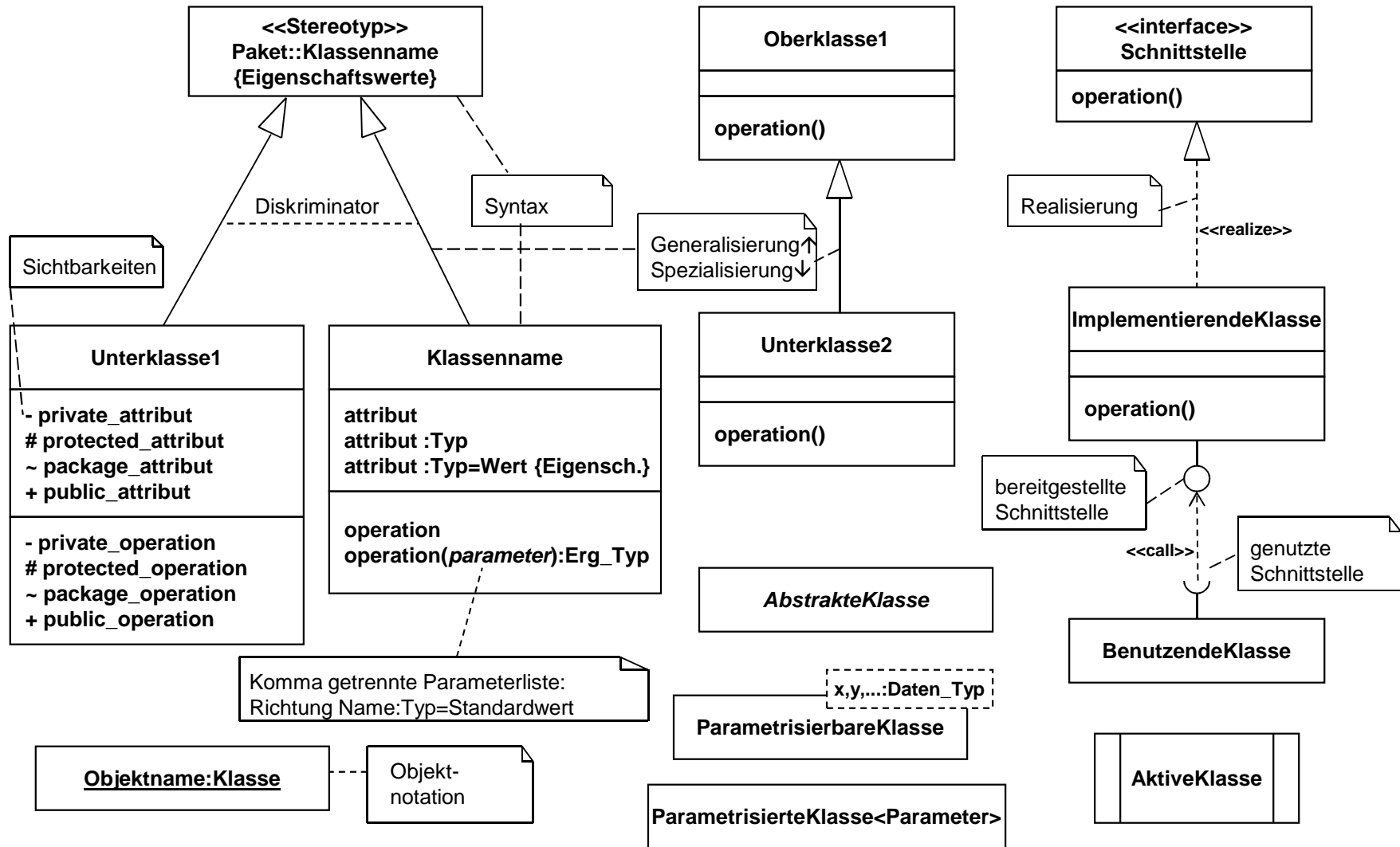

Klassendiagramm 2 (Assoziationen)

Class Diagram

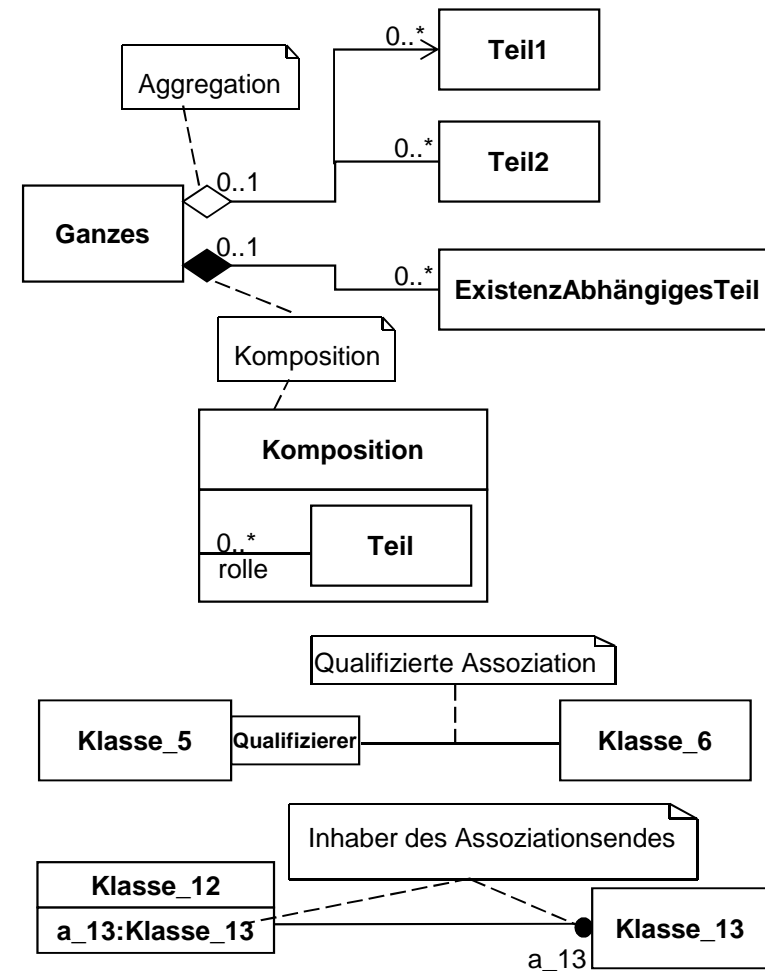
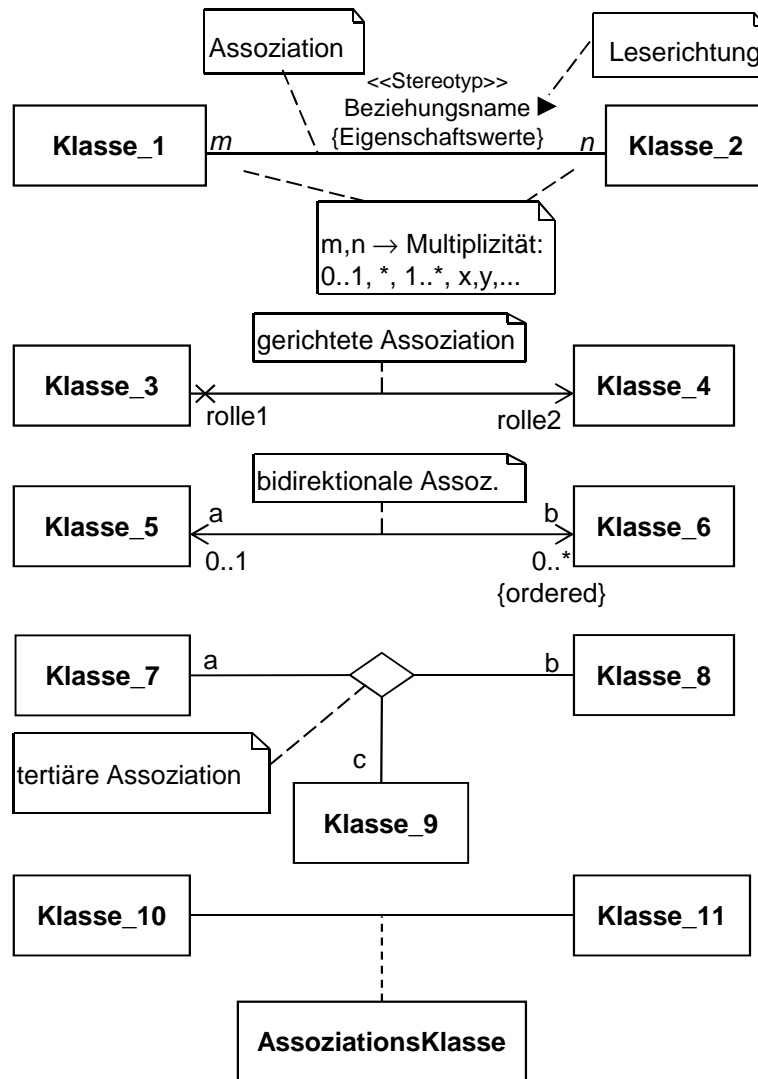

Kompositionsstrukturdiagramm

Composite Structure Diagram

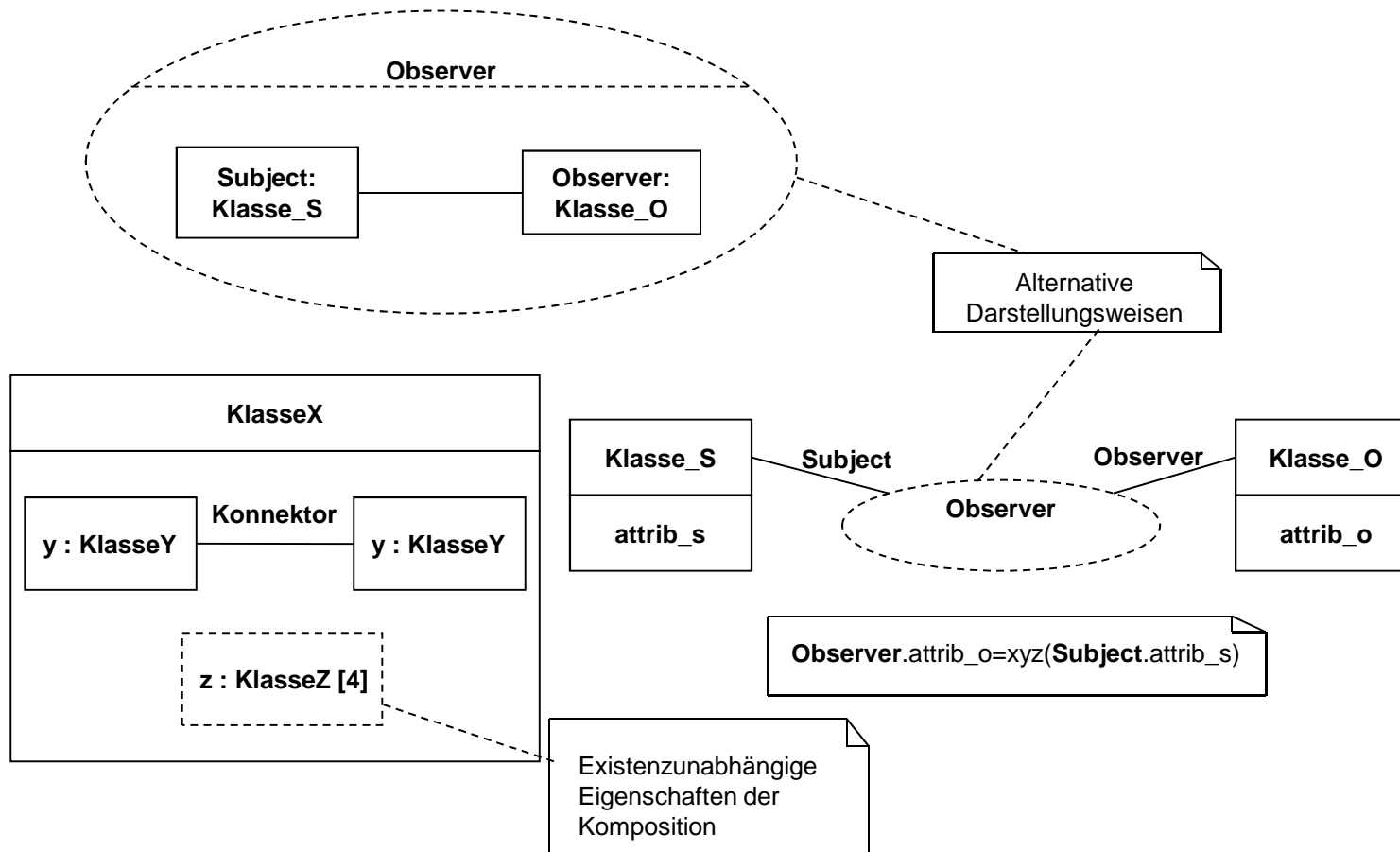

Anwendungsfalldiagramm

Use Case Diagram

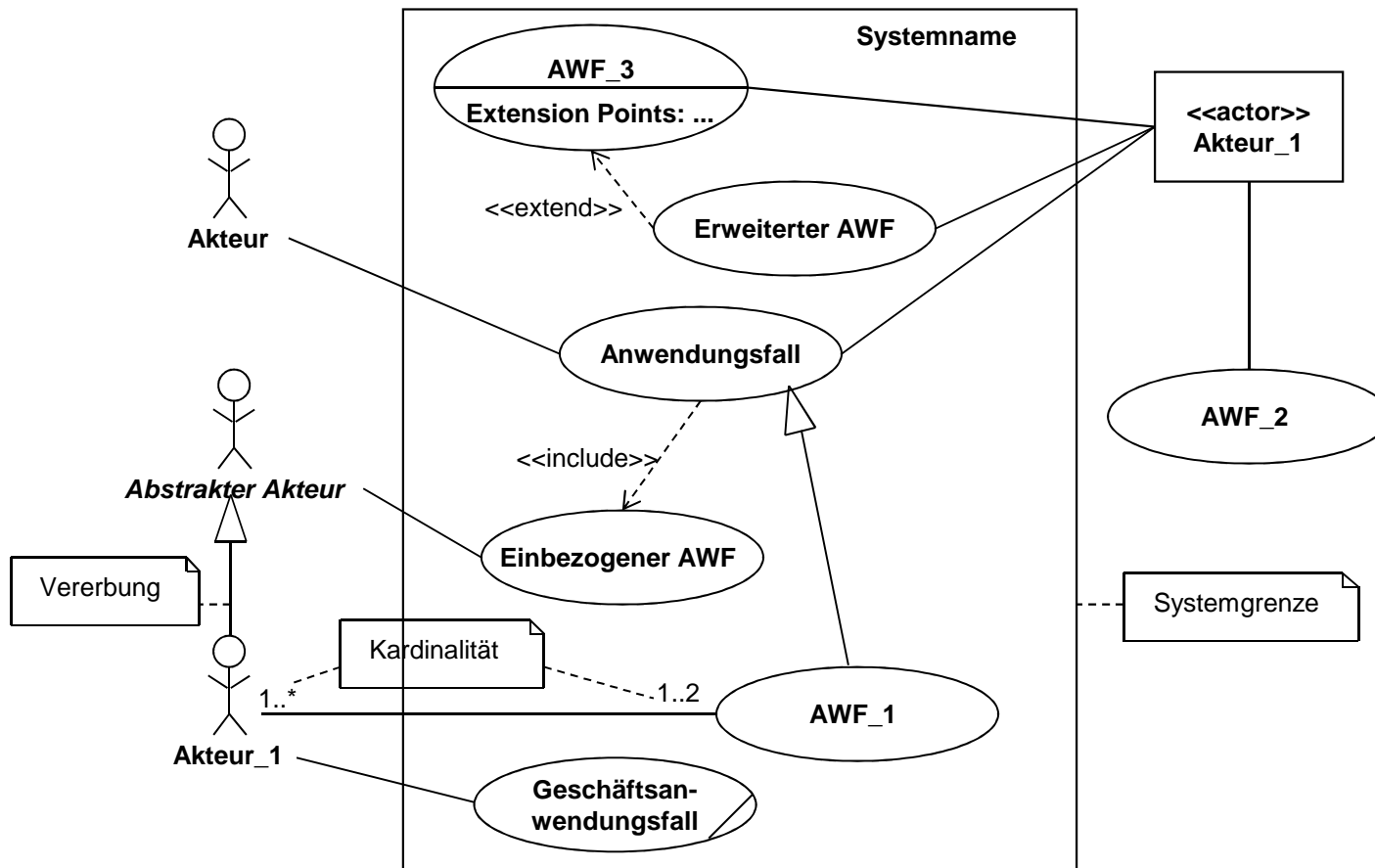

Aktivitätsdiagramm 1

Activity Diagram

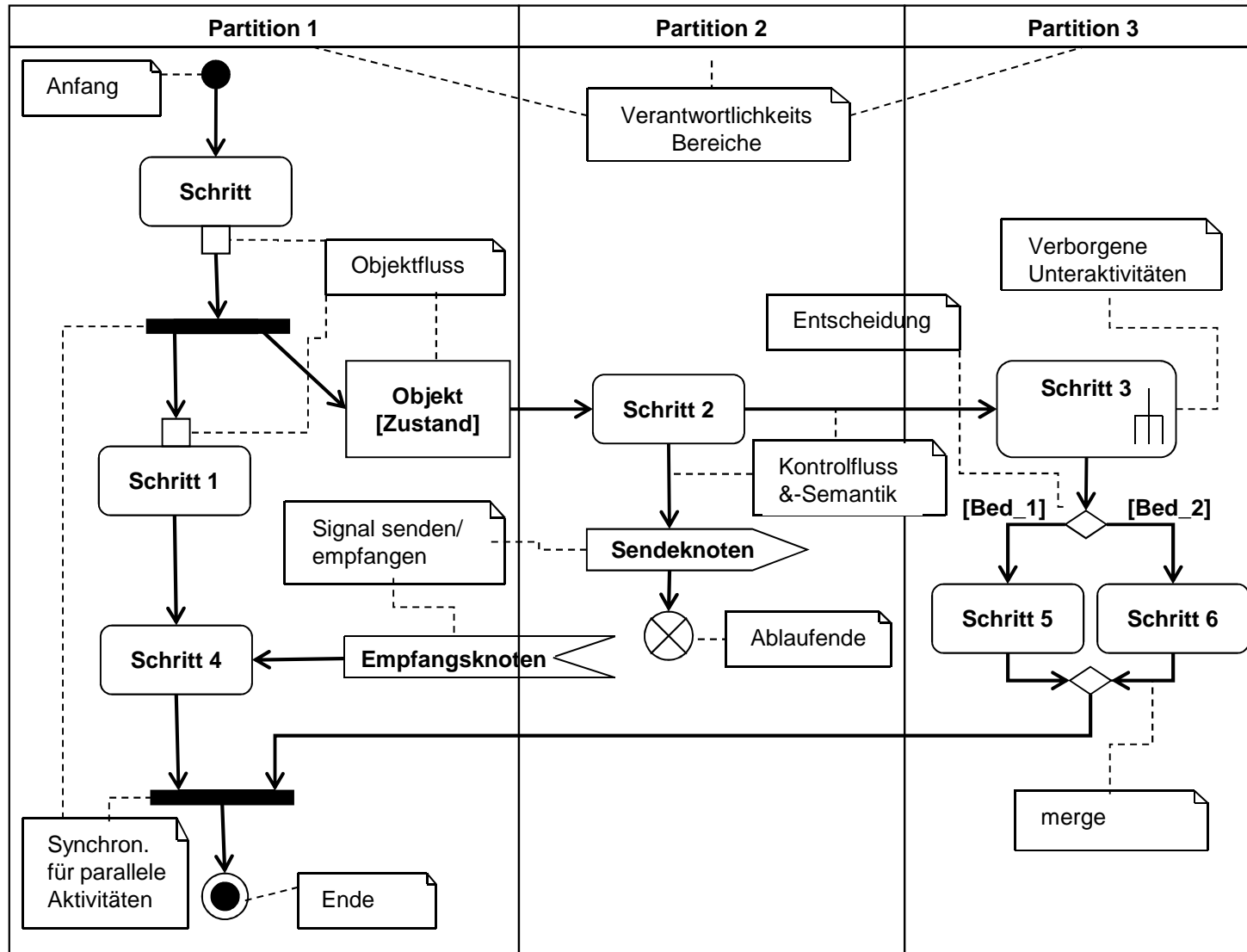

Aktivitätsdiagramm 2

Activity Diagram

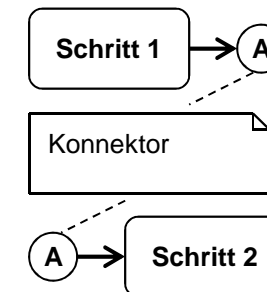
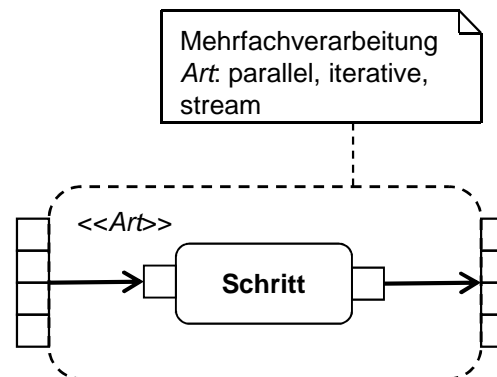
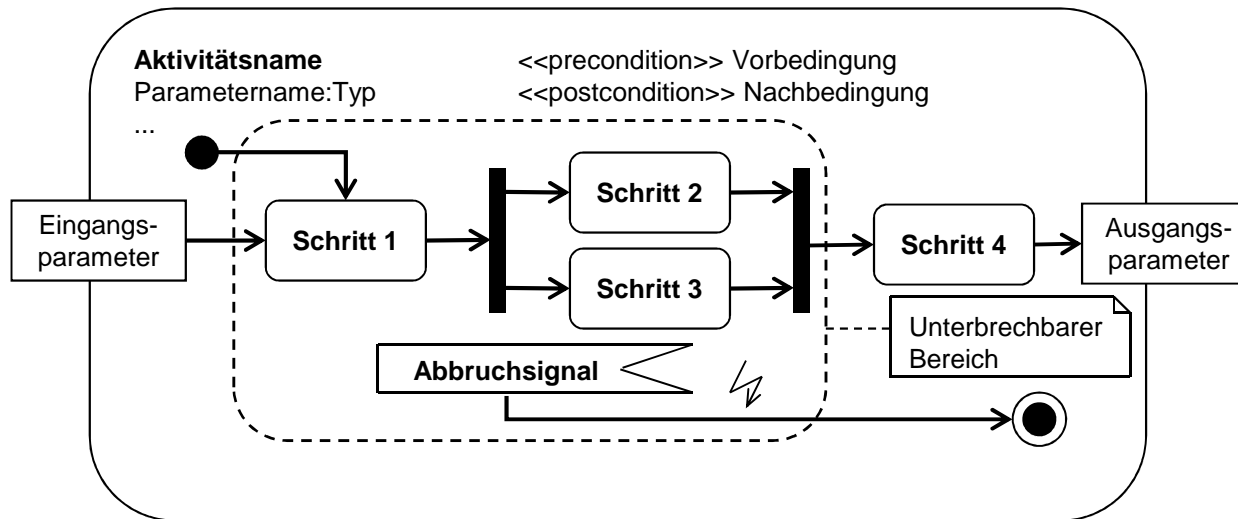

Interaktionsübersichtsdiagramm

Interaction Overview Diagram

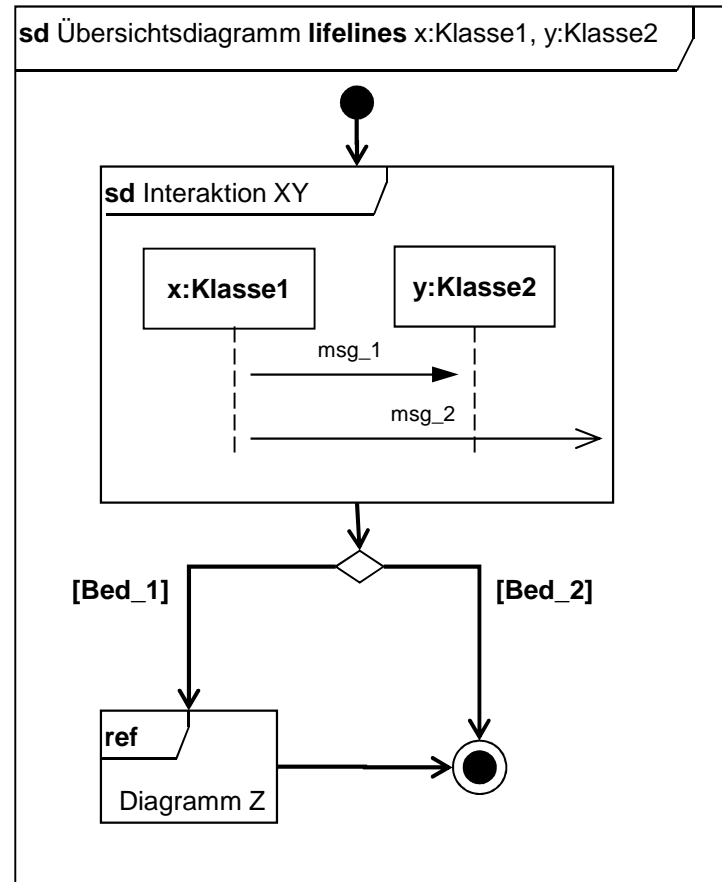

Zustandsdiagramm

Statechart Diagram

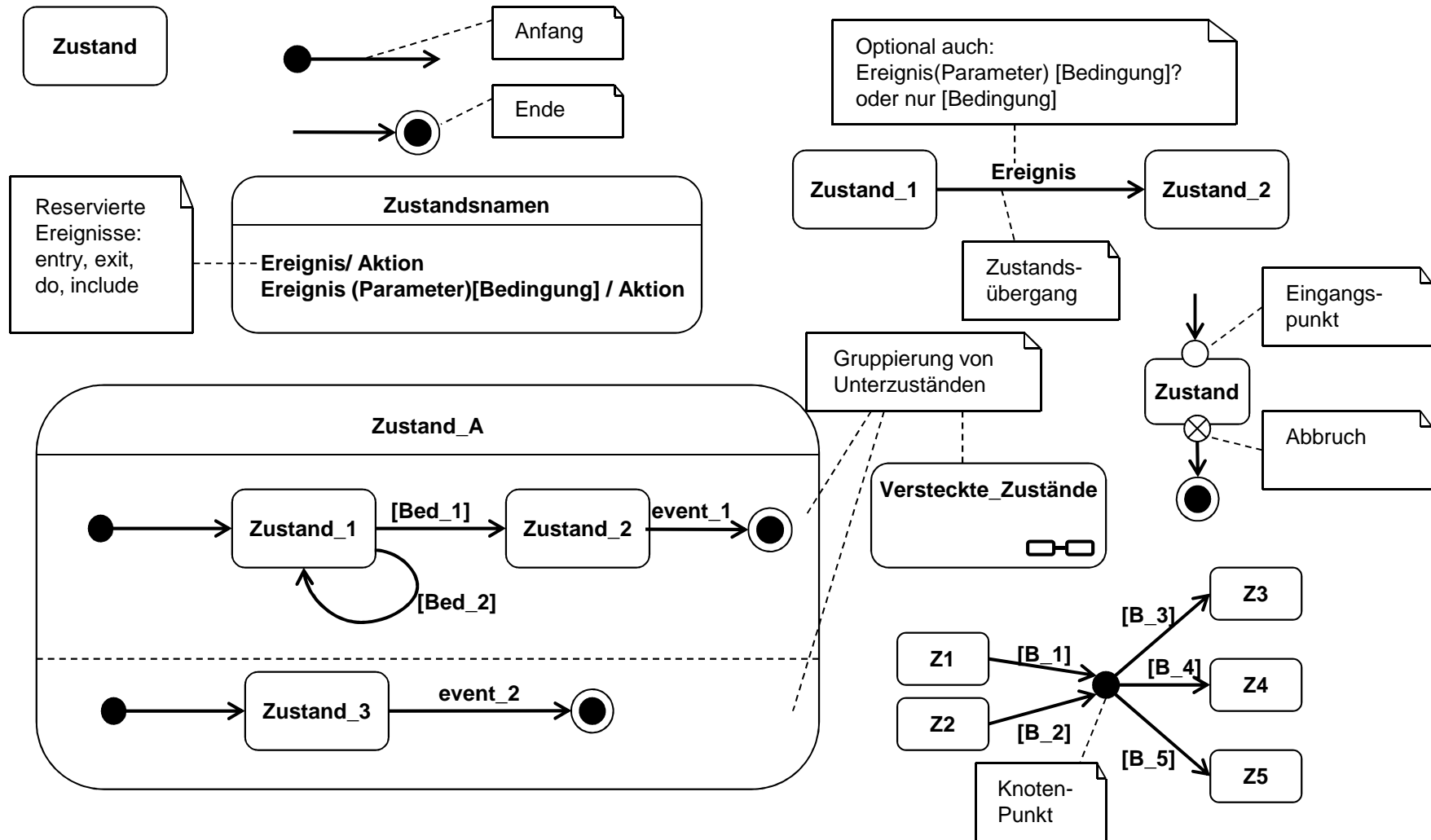

Zeitdiagramm

Timing Diagram

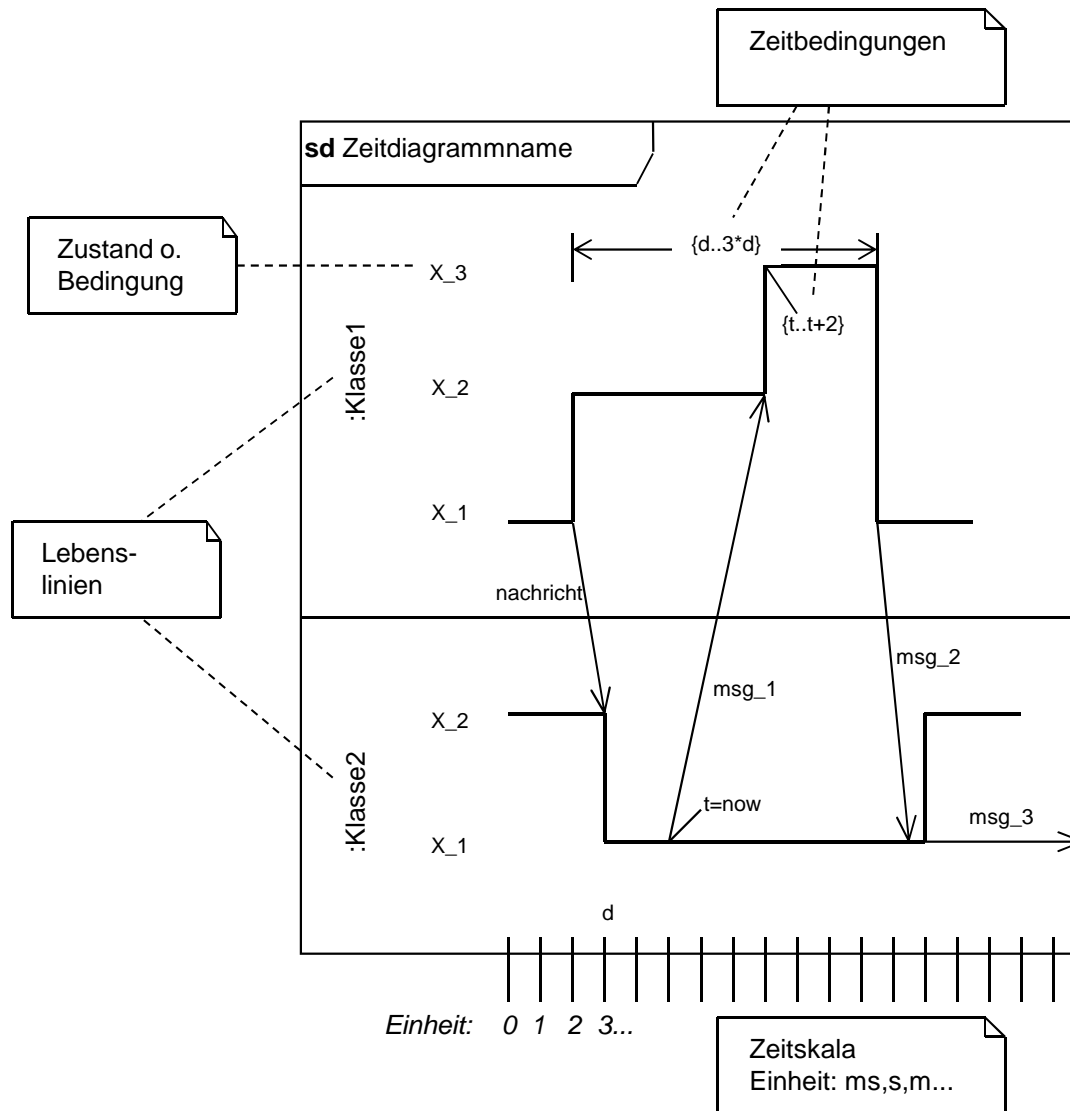

Sequenzdiagramme

Sequence Diagram



Orientation in Objects

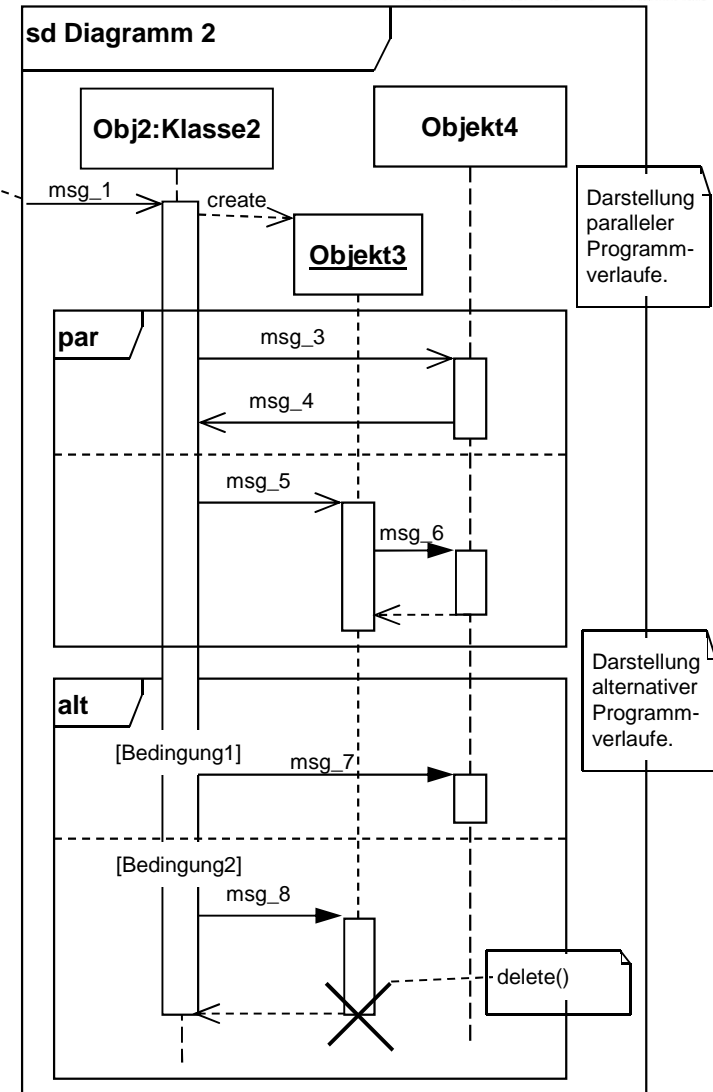
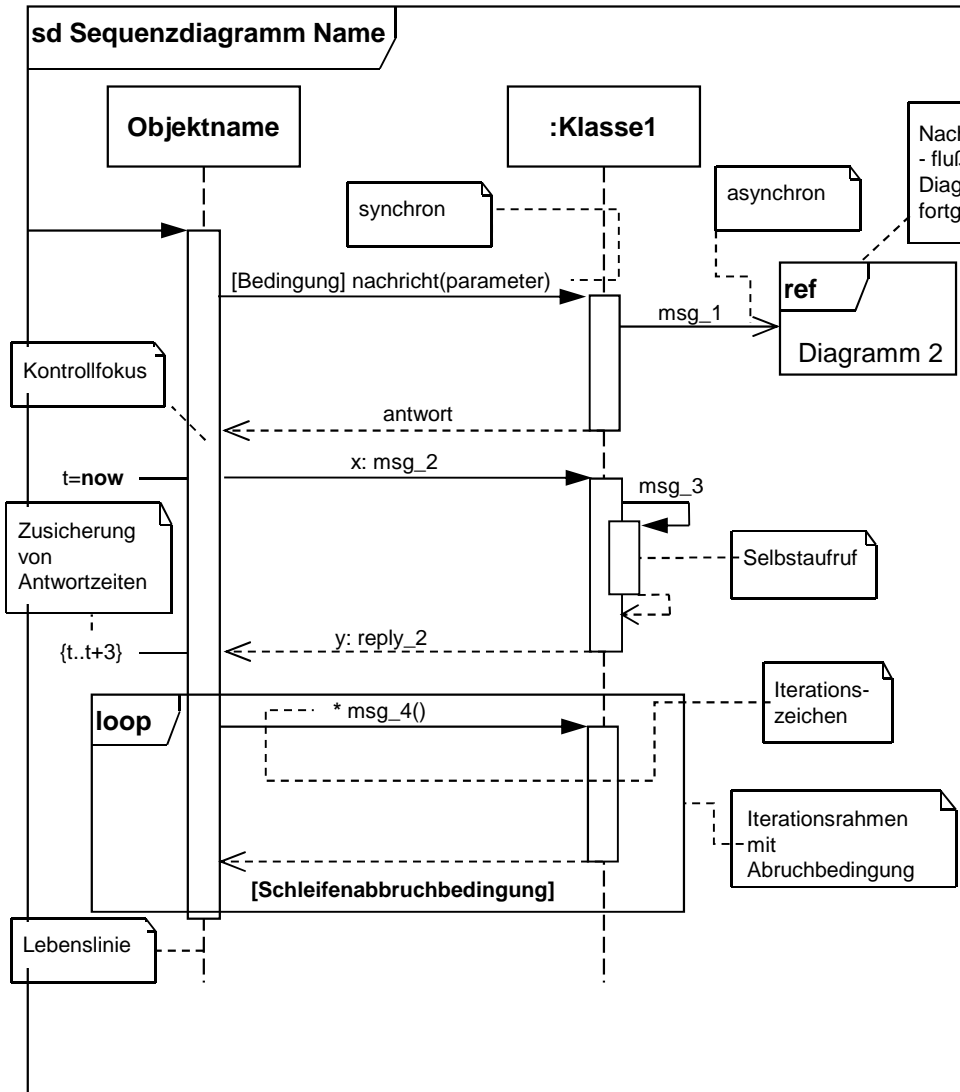

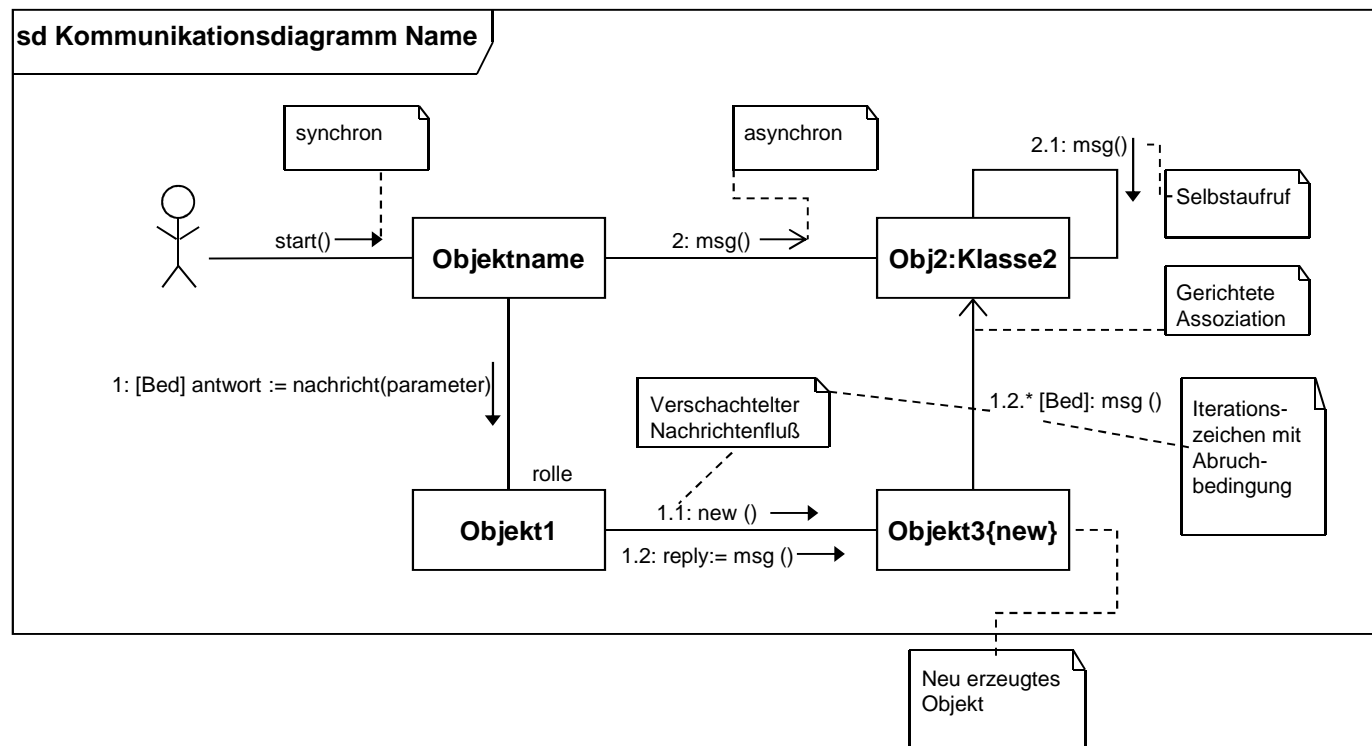

Komponentendiagramm

Component Diagram

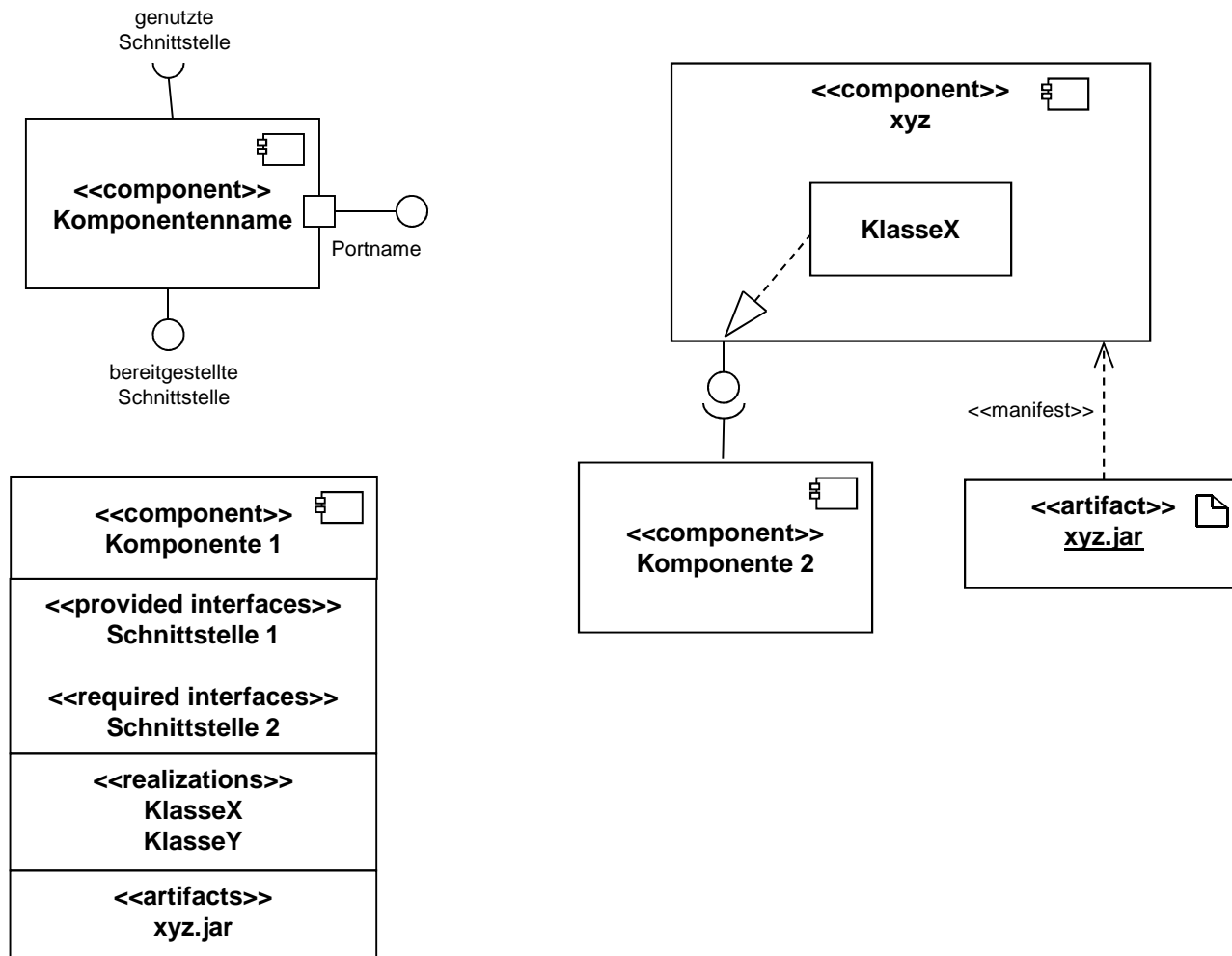

Verteilungsdiagramm

Deployment Diagram

